

Schaltkasten für Leitbatterie

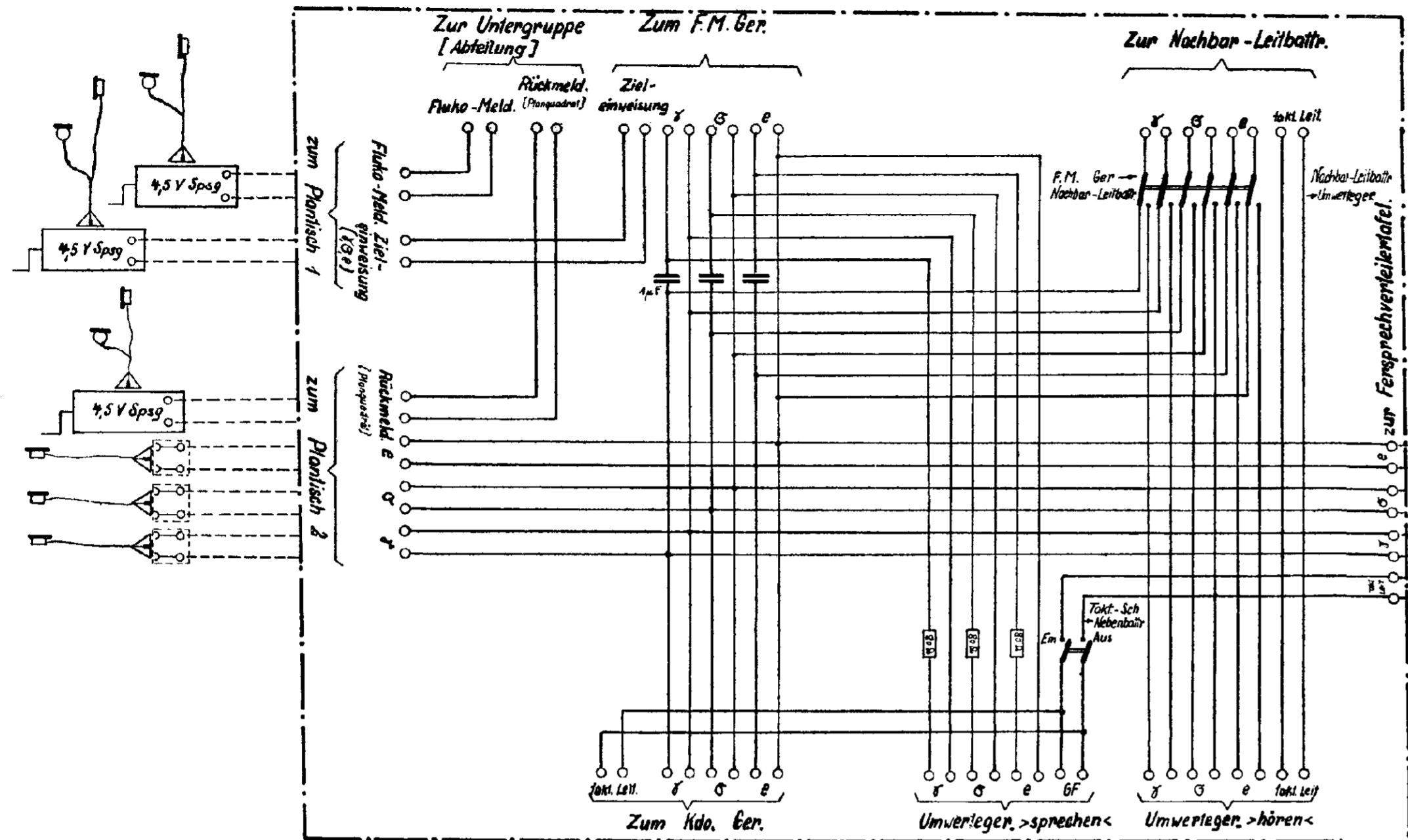

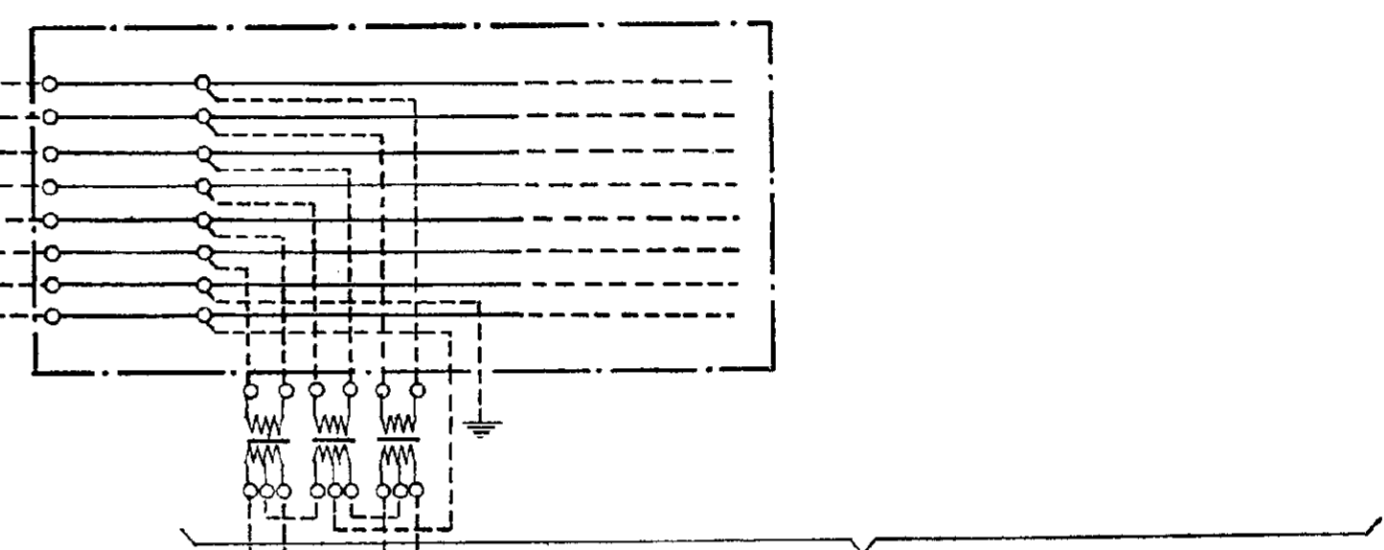

Fernsprechverteilerkasten

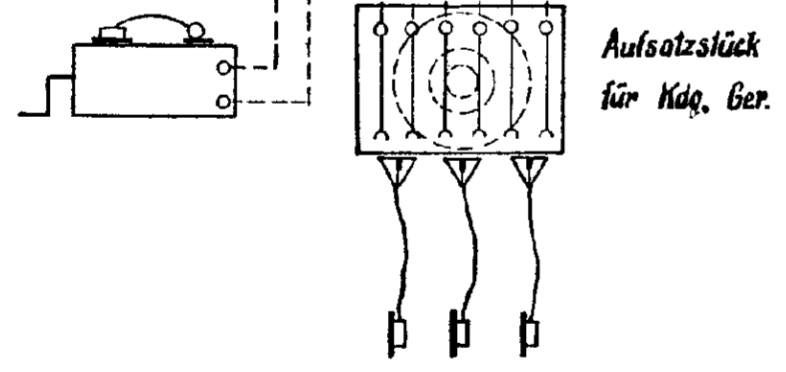

zu Nebenbatterien zur Scheinwerferumwertung und zum Leitscheinwerfer

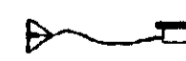

-  Sprechgarnitur
-  Hörgarnitur
-  Fernsprechgarnitur
-  Feldhandapparat

Anschlussklemmen befinden sich innerhalb des Schaltkastens

4.5 V Batterie

